

Date: _____ Lieu: _____
Toureno: _____ Catégorie: _____
Officiel: _____ Feuille no: _____

Pool A

	GR	1	2	3	4	Rang
1x2		█				
3x4			█			
1x3				█		
2x4					█	
1x4						█
2x3						

A-2 R

C-1 R

Pool B

	GR	1	2	3	4	Rang
1x2		█				
3x4			█			
1x3				█		
2x4					█	
1x4						█
2x3						

B-2 R

D-1 R

Pool C

	GR	1	2	3	4	Rang
1x2		█				
3x4			█			
1x3				█		
2x4					█	
1x4						█
2x3						

C-2 R

A-1 R

Pool D

	GR	1	2	3	4	Rang
1x2		█				
3x4			█			
1x3				█		
2x4					█	
1x4						█
2x3						

D-2 R

B-1 R

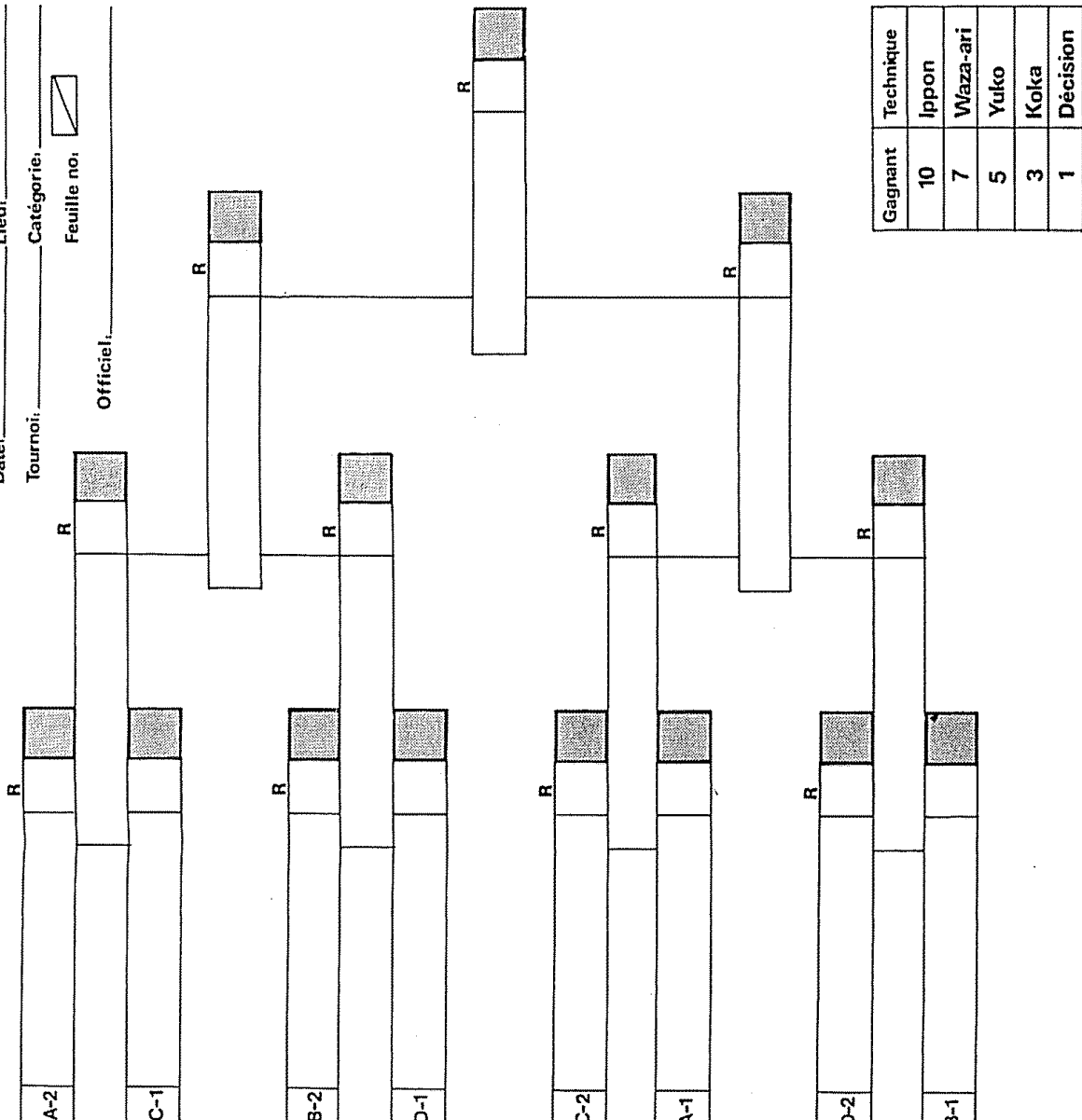

Gagnant	Technique
10	Ippon
7	Waza-ari
5	Yuko
3	Koka
1	Décision

DATE: _____ LIEU: _____

TOURNOI: _____ CATEGORIE: _____

POULE DE 6	NOMS PRENOMS	CLUBS	KYU DAN	1	2	3	4	5	6	7	TOTAUX
4 COMBATS											
1X2	3X6		1	X							
3X5	1X4		2		X						
2X6	5X6		3			X					
1X5			4				X				
4X6			5					X			
2X3			6						X		
4X5			7							X	
1X3											
2X4											

POULE DE 7	NOMS PRENOMS	CLUBS	KYU DAN	1	2	3	4	5	6	7	TOTAUX
4 COMBATS											
2X6	3X7		1	X							
3X5	2X4		2		X						
4X7	1X5		3			X					
1X2	6X7		4				X				
5X6			5					X			
1X3			6						X		
4X6			7							X	
5X7											
2X3											
1X4											

GAGNANT	TECHNIQUE
10	IPPON
7	WAZA ARI
5	YUKO
3	KOKA
1	DECISION

POULE DE 8 4 COMBATS CHAQUE

DATE: _____ LIEU: _____

TOURNOI: _____ CATEGORIE: _____

ORDRE DES COMBATS POOL DE	NOMS										CLUBS	DAN KYU	1	2	3	4	5	6	7	8	9	10	TOTAUX	
	7	8	9	10																				
1X3																								
2X4																								
5X7																								
6X8																								
1X4																								
2X5																								
3X7																								
4X8																								
1X5																								
2X6																								
7X4																								
5X8																								
2X3																								
1X6																								
6X7																								
3X8																								

GAGNANT	TECHNIQUE	PERDANT
10	IPPON	0
7	WAZA ARI	0
5	YUKO	0
3	KOKA	0
1	DECISION	0

FT 259 (4.77)

DATE: _____ LIEU: _____
 TOURNOI: _____ CATEGORIE: _____

POULE DE 9 4 COMBATS CHAQUE

ORDRE DES COMBATS		NOMS	CLUBS	DAI KYU	1	2	3	4	5	6	7	8	9	10	TOTAUX
7	8														
		1X3			X										
		2X4			X										
		6X8			X	X									
		7X9			X	X	X								
		1X4					X								
		2X5					X								
		6X3					X								
		1X5					X								
		2X7					X								
		4X9					X								
		5X8					X								
		1X6					X								
		3X7					X								
		8X4					X								
		5X9					X								
		2X6					X								
		3X5					X								
		7X8					X								
		9X6					X								

GAGNANT	TECHNIQUE	PERDANT
10	IPPON	0
7	MAZA ARI	0
5	YUKO	0
3	KOKA	0
1	DECISION	0

DATE: _____ LIEU: _____
 TOURNOI: _____ CATEGORIE: _____

POULE DE 10 5 COMBATS CHAQUE

ORDRE DES COMBATS POOL DE	NOMS										CLUBS	DAN KYU		1	2	3	4	5	6	7	8	9	10	TOTAUX
	7	8	9	10																				
1X3																								
8X10																								
2X4																								
5X9																								
7X10																								
1X6																								
4X8																								
2X7																								
3X5																								
6X9																								
1X4																								
2X6																								
8X9																								
3X7																								
4X10																								
1X5																								
7X9																								
2X8																								
3X6																								
1X7																								
2X5																								
6X10																								
3X8																								
4X9																								
5X10																								

GAGNANT	TECHNIQUE	PERDANT
10	IPPON	0
7	WAZA ARI	0
5	YUKO	0
3	KOKA	0
1	DECISION	0



TOURNOI : _____
 LIEU : _____
 DATE : _____

DIVISION : _____
 SEXE : _____
 CATEGORIE : _____
 TEMPS DES COMBATS : _____

1	
2	
3	
3	

POOL A

ORDRE DES COMBATS	POOL DE					NOMS CLUBS	GR	1	2	3	4	5	VIC.	Fobh	Kong
	3	4	5												
1-2	1x2	1x2	3x4	3x4	1x5		1								
2-3	1x3	1x3	2x4	2x3	4x5		2								
1-3	1x4	2x3	1x3	1x3	2x5		3								
					1x4		4								
					3x5		5								
					2x4										

A1

3^e

B2

GAGNANT TECHNIQUE	
10	IPPON
7	WAZA-HARI
5	YUKO
3	KOKA
1	DÉCISION

7^{er}

POOL B

ORDRE DES COMBATS	POOL DE					NOMS CLUBS	GR	1	2	3	4	5	VIC.	Fobh	Kong
	3	4	5												
1-2	1x2	1x2	3x4	3x4	1x5		1								
2-3	1x3	1x3	2x4	2x3	4x5		2								
1-3	1x4	2x3	1x3	1x3	2x5		3								
					1x4		4								
					3x5		5								
					2x4										

B1

3^e

A2

FIGHT OFF
 (si nécessaire)

DOUBLE ÉLIMINATION MODIFIÉE (avec les favoris 1, 2, 3 et 4), 8 À 16 COMBATTANTS

No	GR	NOMS	CLUB	Ordre des clubs
1			1	1
16			2	2
8			3	3
10			4	4
4			5	5
14			6	6
6			7	7
12			B	8
2				
15				
7				
9				
3				
13				
5				
11				

REPÊCHAGE

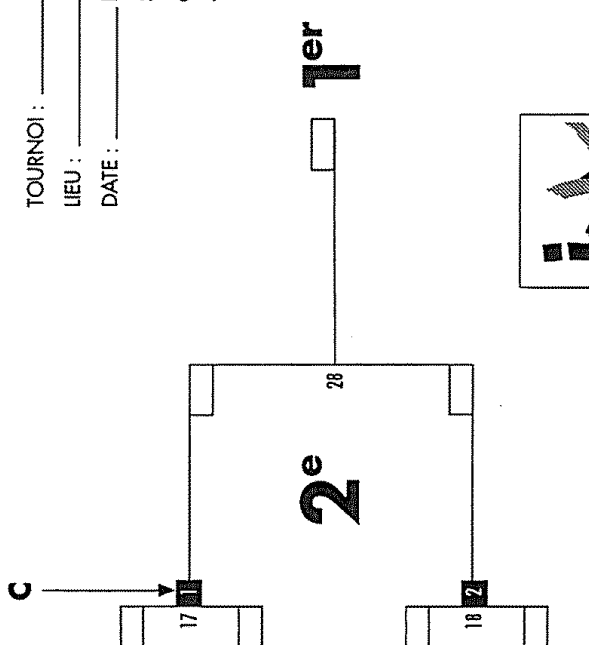
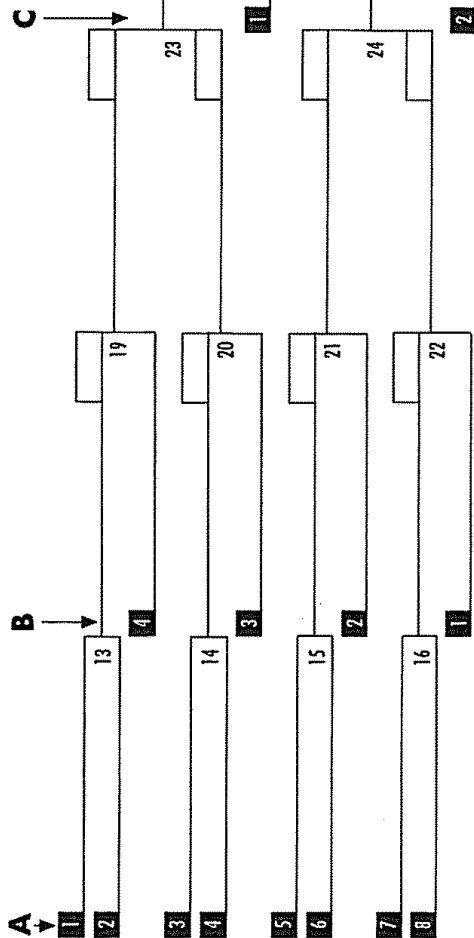

GAGNANT TECHNIQUE	
10	IPPON
7	WAZA-HARI
5	YUKO
3	KOKA
1	DECISION

1
2
3
3

TOURNOI : _____
 LIEU : _____
 DATE : _____
 DIVISION : _____
 SEXE : _____
 CATÉGORIE : _____
 TEMPS DES COMBATS : _____

(N.B. : si il y a 13 combattants, le favori no 3 devra avoir le bye, si possible, à la place du favori no 4).

FIGHT OFF
(si nécessaire)

TOURNOI : _____
 LIEU : _____
 DATE : _____ DIVISION : _____
 SEXE : _____
 CATÉGORIE : _____
 TEMPS DES COMBATS : _____

No	GR	NOMS	DOJO No. de s.
1			
9			
5			
13			
3			
11			
7			
15			
2			
10			
6			
14			
4			
12			
8			
16			

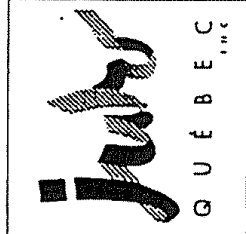
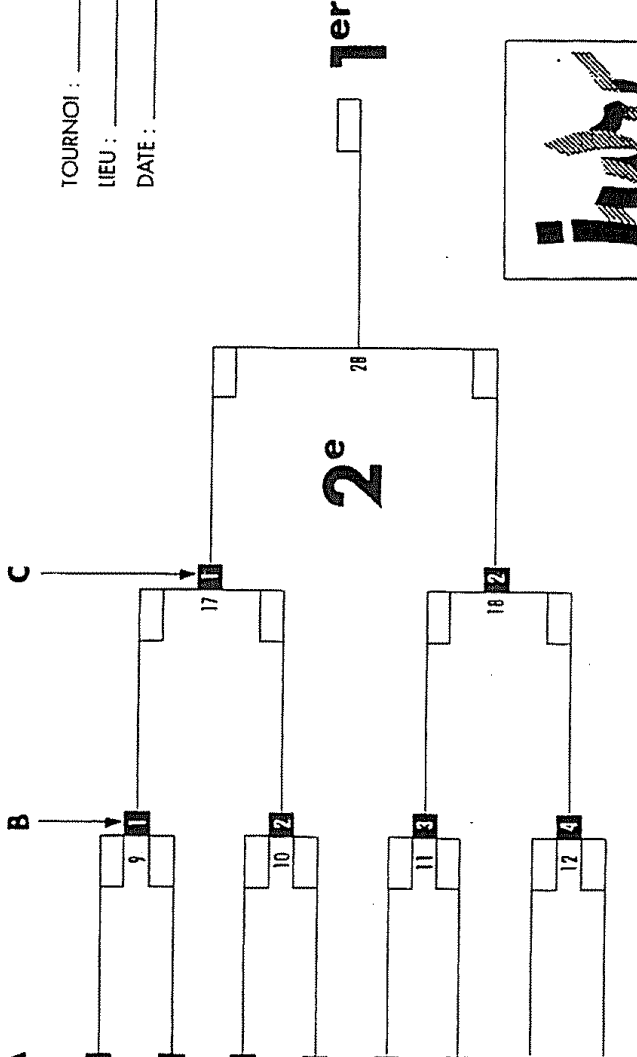

1
2
3
3

GAGNANT TECHNIQUE	
10	IPPON
7	WAZA-HARI
5	YUKO
3	KOKA
1	DÉCISION

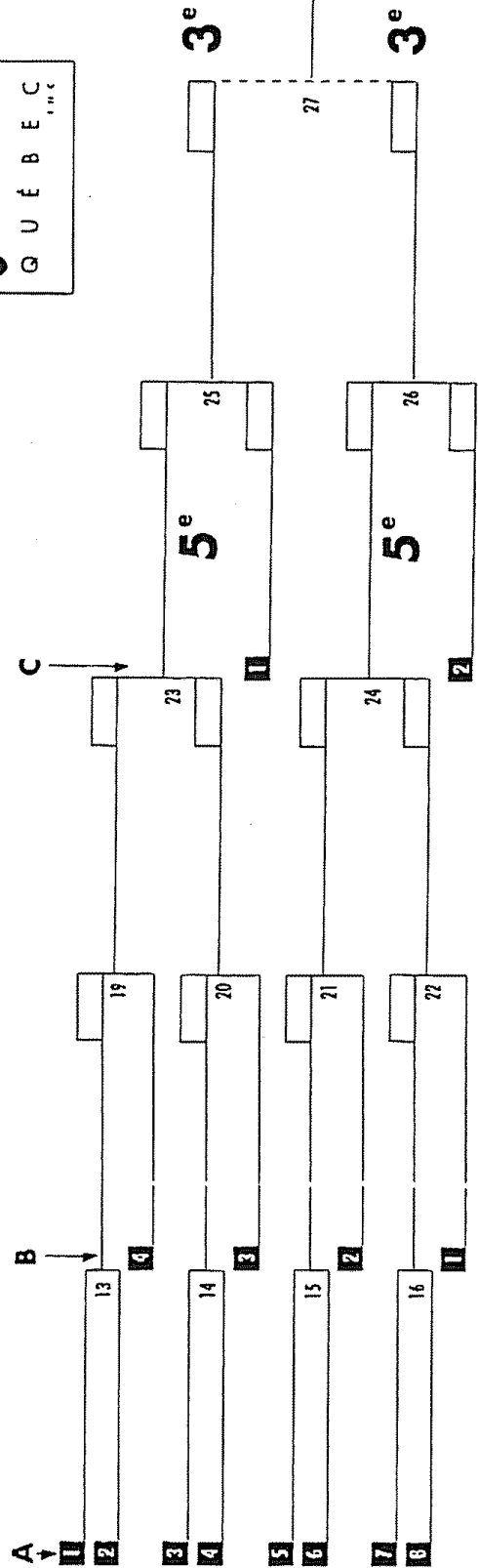

GAGNANT TECHNIQUE	
10	IPPON
7	WAZA-HARI
5	YUKO
3	KOKA
1	DÉCISION

REPÊCHAGE

DOUBLE ÉLIMINATION MODIFIÉE (avec les favoris 1, 2, 3 et 4), 17 À 32 COMBATTANTS

No	GR NOMS	CLUBS Ordre des clubs
1		1
32		2
16		3
18		4
8		5
26		6
10		7
24		8
4		9
30		10
14		11
20		12
6		13
28		14
12		15
22		16
2		17
31		18
15		19
17		20
7		21
25		22
9		23
23		24
3		25
29		26
13		27
19		28
5		29
27		30
11		31
21		32

A ↓

B ↓

C ↓

D ↓

TOURNOI : _____

LIEU : _____

DATE : _____

DIVISION : _____

SEXE : _____

CATÉGORIE : _____

TEMPS DES COMBATS : _____



1^{er}

2^e

60

1^{er}

49

50

33

34

35

36

17

18

19

20

21

22

23

24

1

2

3

4

5

6

7

8

9

10

11

12

13

14

15

16

1

2

3

3

(N.B. : si il y a 29 combattants, le favori no 3 devra avoir le bye, si possible, à la place du favori no 4).

DOUBLE ÉLIMINATION MODIFIÉE, 17 À 32 COMBATTANTS

TOURNOI : _____
 LIEU : _____
 DATE : _____ DIVISION : _____
 SEXE : _____
 CATÉGORIE : _____
 TEMPS DES COMBATS : _____



2^e **1^{er}**

A ↓

B ↓

C ↓

D ↓

No	GR	NOMS	CLUBS
			Ordre des club
1			1
17			17
9			2
25			2
5			3
21			3
13			4
29			4
3			5
19			5
11			6
27			6
7			7
23			7
15			8
31			8
2			9
18			9
10			10
26			10
6			11
22			11
14			12
30			12
4			13
20			13
12			14
28			14
8			15
24			15
16			16
32			16

17	1
18	2
19	3
20	4
21	5
22	6
23	7
24	8
33	1
34	2
35	3
36	4
49	1
50	2
60	

1
2
3
3

DOUBLE ÉLIMINATION MODIFIÉE, 17 À 32 COMBATTANTS REPÊCHAGE

DIVISION : _____
 CATÉGORIE : _____
 TEMPS DE COMBATS : _____

GAGNANT TECHNIQUE	
10	IPPON
7	WAZA-HARI
5	YUKO
3	KOKA
1	DÉCISION

